

TACO[®]
MARINE

SPORT FISHING CATALOG 2017



tacomarine.com



TABLE OF CONTENTS

Outrigger Mounts.....	3
Universal Mount.....	7
Outrigger Poles.....	8
Rigging Kits & Components.....	10
Rod Holders.....	12
Rod Storage.....	13
Dockside Products.....	20
Poly Products.....	23
LED Lighting.....	26
Seating.....	30
Leaning Posts.....	34
Accessories.....	37
Reference.....	42
Index.....	46



TACO Marine Pros want to share their tips with you.



TACO Marine Product Knowledge gives you more insight into our products.

Grand Slam 380 Top Mount



Stainless Steel Type 316 & Anodized Aluminum

- > Accepts 1-1/2" heavy-duty outriggers
- > Versatile design for use on soft tops and hard tops up to 2" thick
- > Rotator handle offset at 30° for added hand clearance
- > Heavy-duty grip for sure-handling to lock-in 12 fishing positions
- > Fold-up crank handle for maximum under-top clearance
- > Locking pin secures outriggers in locked position
- > Includes 4" x 6" x 1/2" mounting base with easy bolt-down installation
- > Fits TACO Marine Outrigger-Ready pre-drilled extrusion plates

- > Available with increased body length for thicker hard tops up to 4-1/2" (GS-380XL)
- > Ideal for up to 50' boats
- > Sold in Pairs

Patent #7,114,283



PRODUCT KNOWLEDGE



Improved Fold-up Crank Handle offers a larger, firmer grip that allows for quicker outrigger pole position adjustment.

NEW!
longer body

Turn to page 44 for additional information

GS-380XL

GS-380

Part #	Description	Height	Width	Depth
GS-380	Grand Slam 380 Outrigger Top Mount w/30° Offset Handle	16-3/4"	15-1/8"	4"
GS-380XL	Grand Slam 380XL Outrigger Top Mount w/Longer Body	18-1/4"	15-1/8"	4"

Also Sold Separately - Turn to page 40 for more information

BP150BSY-320-1

Backing Plate

GSE-1939BLS30

Pre-Drilled Extrusion Plate

WP-150WHA-1

Wedge Plate



BP150



GSE-1939



WP150



OUTRIGGER MOUNTS

Grand Slam 280 Top Mount 3



Stainless Steel Type 316 & Anodized Aluminum

- > Accepts 1-1/2" heavy-duty outriggers
 - > Uses TACO Marine Spline Lock Technology for secure outrigger elevation
 - > Locking pin secures Outriggers in locked position
 - > Versatile design for use on soft tops and hard tops up to 2" thick
 - > Ergonomic shaped rotator lever handle adjusts to desired 12 locking fishing positions
 - > Secure heavy-duty grip for sure handling in rough seas
 - > Safe outrigger positioning from under the top
 - > Sealed to prevent water leakage
 - > Includes 4" x 6" x 1/2" mounting base with easy bolt-down installation
- > Fits TACO Marine Outrigger-Ready pre-drilled extrusion plates
- > Available with 30° offset handle for greater hand clearance (GS-2801)
- > Ideal for up to 36' boats
- > Sold in Pairs

Patent #6,668,745



Spline Lock Technology is an engineered mechanism that allows multiple adjustment positions and prevents slippage while securing outriggers at the desired height position for increased reliability and performance.

Turn to page 44 for additional information

Part #	Description	Height	Width	Depth
GS-280	Grand Slam 280 Outrigger Top Mount	15"	13"	4"
GS-2801	Grand Slam 280 Outrigger Top Mount w/30° Offset Handle	15"	13"	4"

Convenient Kits Available with GS-280 Mount

Includes 2 Mounts/Outrigger Poles/Premium Rigging Kit/Line Caddy

Turn to page 8 & 10 for more information

GS-2841BKA-1

1-1/2" Diameter, 15' Outriggers, Black w/Gold Rings, Line Caddy, Premium Rigging Kit

GS-2841VEL-1

1-1/2" Diameter, 15' Outriggers, Silver w/Gold Rings, Line Caddy, Premium Rigging Kit

GS-2842VEL-1

1-1/2" Diameter, 15' Outriggers, Silver w/Silver Rings, Line Caddy, Premium Rigging Kit



Tele-Outriggers

Premium Rigging Kit

Line Caddy



Grand Slam 170 Top Mount



Stainless Steel Type 316 & Anodized Aluminum

- > Designed for use with standard 1-1/8" outriggers
- > Uses TACO Marine Spline Lock Technology for secure outrigger elevation that locks every 18°
- > Delrin bearings and Stainless Steel internal locking mechanism offer smooth adjustments, secure positioning and prevent movement
- > Rugged, sure-grip knob adjusts and locks-in desired height and laydown position for safe trailering and navigation under bridges
- > Arm with locking feature ensures TACO Marine Outriggers remain securely in place
- > Includes 4" x 6" x 1/2" mounting base with easy bolt-down installation

- > Available as Center Rigger Mount (Sold as Each)
- > Ideal for up to 24' boats
- > Sold in Pairs (GS-170) or as Each (GS-170-2)



Spline Lock Technology is an engineered mechanism that allows multiple adjustment positions and prevents slippage while securing outriggers at the desired height position for increased reliability and performance.

Turn to page 44 for more information

Patent #8,186,095



Part #	Description	Height	Width	Depth
GS-170	Grand Slam 170 Top Mount	5-1/2"	9-3/4"	4"
GS-170-2	Grand Slam 170-2 Center Top Mount	5-1/2"	9-3/4"	4"

Convenient Kits Available with GS-170 Mount

Includes 2 Mounts/Outrigger Poles/Standard Rigging Kit/Line Caddy

Turn to page 8 & 10 for more information

GS-170BKA15-1

1-1/8" Diameter, 15' Outriggers, Black w/Gold Rings, Line Caddy, Standard Rigging Kit

GS-170VEL15-1

1-1/8" Diameter, 15' Outriggers, Silver w/Gold Rings, Line Caddy, Standard Rigging Kit



Tele-Outriggers

Standard Rigging Kit

Line Caddy



OUTRIGGER MOUNTS

Striker Base Gunnel Mount 3

Patent #5,921,196



Polished Stainless Steel Type 316

- > Unique Hex nut locking design offers multiple fishing positions
- > Ambidextrous 45° arms ideal for trolling from gunnel
- > Removable arms allow for unobstructed gunnel
- > Sold in Pairs



Drill template available...

You will need to cut a 45° hole for installation. Visit TacoMarine.com for drilling template. Use a 1-1/2" or 2" hole saw to cut the 45° angle, then file to get a perfect fit. Use a sealant such as a marine grade silicone under the plate for a watertight seal.



Part #	Description	Height	Base Dimension	OD
F16-0150-F	Striker Base Gunnel Mount w/45° Arm	15-1/2"	5-3/4"L x 2-7/8"W	1-1/2"
F16-0212-F	Striker Base Gunnel Mount w/45° Arm	15-1/2"	5-1/8"L x 2-5/8"W	1-1/8"

Also Sold Separately - Turn to page 40 for more information

M17-1564P-4

Replacement 45° Arm for F16-0212-F

M17-1564P-6

Replacement 45° Arm for F16-0150-F

Sold as Each

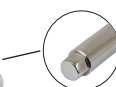

Close Up of Hex Nut Arm

Center Rigger Fixed Mount 3



Polished Stainless Steel Type 316

- > Clamp-on installation
- > Fits 3/4" and 1" IPS
- > Anti-rotation set screw
- > For use with 8' Center Rigger Pole
- > Sold as Each



Part #	Description	Height	Width
F16-0311C-1	Clamp-On Center Rigger Fixed Mount	7-1/2"	2-1/8"

Convenient Kits Available with Center Rigger Mount

Includes 1 Mount/Outrigger Pole/Center Rigging Kit

Turn to page 8 & 10 for more information

F16-0311BKA8SB

1-1/8" Diameter, 8' Center Rigger in Black w/Gold Rings, Center Rigging Kit

F16-0311VEL8SB

1-1/8" Diameter, 8' Center Rigger in Silver w/Gold Rings, Center Rigging Kit



Center Rigger



Center Rigging Kit



Grand Slam 890 Universal Mount



Anodized Aluminum, Light Brushed Body
Polished Stainless Steel Type 316 Crank Handle

- > Unique design allows for raising and lowering antenna, flag, light pole or antenna light from under the top
- > Folding crank handle stores flush into base and does not require power
- > Fits standard 1" x 14 threaded rod for antenna, flag pole or anchor light
- > Delrin roller bearings provide for smooth operation and durability
- > Round mounting plate included
- > Sold as Each



Patent Pending

PRODUCT KNOWLEDGE



Folding crank handle stores flush into vase.



Easy to install...

Universal Mount for VHF antenna, flag pole or anchor light by allowing you to raise and lower without climbing onto the gunnels and with a crank lever that hides away when not needed.

This unique design allows for raising and lowering of an antenna or flag pole from under the top with your hand, no power required. This represents a significant convenience and safety feature for boaters since the antenna can be adjusted without having to climb up top to adjust.

Part #	Description	Height	Width	Hand Crank
GS-890	Grand Slam 890 Universal Mount	9"	5"	2-3/4"



OUTRIGGER POLES

Tele-Outrigger Poles **3**



Anodized Aluminum w/Stainless Steel Type 316 Rings & Tips

- > Telescopes to less than 6' for bridge clearance, trailering and storage
- > Designed for use with Grand Slams, Striker Bases and other universal mounts that accept 1-1/2" or 1-1/8" Outriggers
- > 15' Poles ideal for up to 26' boats, 18' Poles ideal for up to 34' boats
- > Sold in Pairs

PRODUCT KNOWLEDGE

IM



Precision locking pin.

KITS

AVAILABLE
Includes Mounts, Rigging Components & Line Caddy (page 4 & 5)

Patent #5,921,196



Part #	Length	Diameter	Color
OT-0441BKA15	15'	1-1/8"	Black w/Gold Rings & Tips
OT-0441VEL15	15'	1-1/8"	Silver w/Gold Rings & Tips
OT-0442BKA15	15'	1-1/8"	Black w/Silver Rings & Tips
OT-0442VEL15	15'	1-1/8"	Silver w/Silver Rings & Tips
OT-0541BKA15-HD	15'	1-1/2"	Black w/Gold Rings & Tips
OT-0541VEL15-HD	15'	1-1/2"	Silver w/Gold Rings & Tips
OT-0542BKA15-HD	15'	1-1/2"	Black w/Silver Rings & Tips
OT-0542VEL15-HD	15'	1-1/2"	Silver w/Silver Rings & Tips
OT-0551BKA186	18'	1-1/2"	Black w/Gold Rings & Tips
OT-0551VEL186	18'	1-1/2"	Silver w/Gold Rings & Tips
OT-0552BKA186	18'	1-1/2"	Black w/Silver Rings & Tips
OT-0552VEL186	18'	1-1/2"	Silver w/Silver Rings & Tips

Center Rigger Poles **3**



Anodized Aluminum w/Stainless Steel Type 316 Rings & Tips

- > Telescopes to less than 5'1"
- > Designed for use with TACO Marine Center Rigger Fixed Mount and other universal mounts that accept 1-1/8" center riggers
- > 8' Pole ideal for up to 30' boats, 12' Pole ideal for up to 40' boats
- > Sold as Each

PRODUCT KNOWLEDGE

IM



Precision locking pin.

KITS

AVAILABLE
Includes Mounts, Rigging Components & Line Caddy (page 6)



Part #	Length	Diameter	Color
OC-0421BKA8	8'	1-1/8"	Black w/Gold Rings & Tips
OC-0421VEL8	8'	1-1/8"	Silver w/Gold Rings & Tips
OC-0422BKA8	8'	1-1/8"	Black w/Silver Rings & Tips
OC-0422VEL8	8'	1-1/8"	Silver w/Silver Rings & Tips
OC-0432BKA116	12'	1-1/8"	Black w/Silver Rings & Tips
OC-0432VEL116	12'	1-1/8"	Silver w/Silver Rings & Tips

Also Sold Separately - Turn to page 11 & 40 for more information

COK-0024
Carry Bag



F40-0030BKA-1
Outrigger Line Caddy



OUTRIGGER POLES

Carbon Fiber Tele-Outrigger Poles



Carbon Fiber w/Stainless Steel Type 316 Rings & Tips

- > Adjustable roller line caddy with brass rollers that allows for easy rigging to the t-top or the gunnel and only used on Carbon Fiber Poles
- > 16' Pole ideal for under 35' boats, 20' Pole ideal for up to 50' boats
- > Sold in Pairs

PRODUCT KNOWLEDGE
TM



Includes carry bag & line caddy.

Precision locking pin.

Patent Pending Swivel Roller Design



Part #	Length	Diameter	Color
OT-3160CF	16'	1-1/2"	Black w/Silver Rings & Tips
OT-4200CF	20'	1-1/2"	Black w/Silver Rings & Tips



The benefits of trolling

When trolling with outriggers you can troll with more lines in the water, thus pulling more bait which simulates a school of fish. Outriggers will eliminate tangled lines. Each outrigger can accommodate one or two lines from your rods and reels. The line is used with a release clip that extends to the end of your outrigger. When a fish strikes your bait, the release clip will allow your fishing line to come free of the outrigger so you can reel in the fish. **NOTE: To prevent potential damage to your outriggers, do not run at high speeds with poles extended.**

Turn to page 42-43 for more information

Carbon Fiber Center Rigger Poles



Carbon Fiber w/Stainless Steel Type 316 Rings & Tips

- > Telescopes to less than 5'1" for bridge clearance, trailering and storage
- > Ideal for up to 40' boats
- > Sold as Each

PRODUCT KNOWLEDGE
TM



Includes carry bag & line caddy.

Precision locking pin.

Patent Pending Swivel Roller Design



Part #	Length	Diameter	Color
OT-2120CF	10'	1-1/8"	Black w/Silver Rings & Tips
OT-2160CF-2	16'	1-1/2"	Black w/Silver Rings & Tips



RIGGING KITS

Premium Rigging Kit



- > Single Roller Pulley Shock Cord w/ Stainless Steel Snap Hook and Eye Insert, Black Dacron Rigging Cord, Adjustable Tension Release Clip, 1-1/4" Outrigger Line Ball Stops, Pad Eye w/ Screws, Double Sleeve Crimp, Swivel, Snap Swivel, Quick Dry Mesh Bag
- > Rigs up to 22' outriggers
- > Sold as Each



Part #	Description	Length
RK-0001PB	Single Rigging Kit	100'
RK-0002PB	Double Rigging Kit	200'

Standard Rigging Kit



- > Glass Ring w/ Brass Snap Clip, Black Dacron Rigging Cord, Adjustable Tension Release Clip, 1-1/4" Outrigger Line Ball Stops, Pad Eye w/ Screws, Double Sleeve Crimp, Swivel, Snap Swivel, Quick Dry Mesh Bag
- > Rigs up to 22' outriggers
- > Sold as Each



Part #	Description	Length
RK-0001SB	Standard Rigging Kit	100'

Center Rigging Kit



- > Single Roller Pulley Shock Cord w/ Stainless Steel Snap Hook and Eye Insert, Black Dacron Rigging Cord, Adjustable Tension Release Clip, 1-1/4" Outrigger Line Ball Stop, Pad Eye w/ Screws, Double Sleeve Crimp, Swivel, Snap Swivel, Quick Dry Mesh Bag
- > Single kit rigs up to 25' center rigger
- > Sold as Each



Part #	Description	Length
RK-0001PCB	Center Rigging Kit	50'

Premium Mono Rigging Kit



- > Double (or Triple) Roller Pulley Shock Cord w/ Stainless Steel Snap Hook, 1/8" thick 180' coil of Lindgren Pitman 400# Monofilament in Black, Adjustable Tension Release Clips, 1-3/4" Outrigger Line Ball Stops, Stainless Steel Eye Strap and Screws, Double Sleeve Crimps, Coastlock-style Swivels and Snap Swivels, Quick Dry Mesh Bag
- > Sold as Each



Premium Braid Double or Triple Rigging Kit



- > Ronstan Triple Roller Pulley Shock Cord w/ Stainless Steel Snap Hook, 1/8" thick 300' Dacron Rigging Cord in Black, Adjustable Tension Release Clips, 1-3/4" Outrigger Line Ball Stops, Stainless Steel Eye Strap and Screws, Double Sleeve Crimps, Coastlock-style Swivels and Snap Swivels, Quick Dry Mesh Bag
- > Sold as Each



Part #	Description	Length
RK-0002MP	Premium Mono Double Rigging Kit	180'
RK-0003MP	Premium Mono Triple Rigging Kit	180'
RK-0003PB	Premium Braid Triple Rigging Kit	300'



RIGGING KIT COMPONENTS

Rigging Kit Components

- > Quality components for upgrading or repairing Outrigger Rigging Kits
- > Sold in Pairs



COK-0001B-2



COK-0001T-2



COK-0008B-1



F40-0030BKA-1



COK-0017-2 / COK-0018-2



COK-0004G-2



F16-1200-2



COK-0024



COK-0020-2



COK-0021-2



COK-0022-2



COK-0043-1

Part #	Description
COK-0001B-2	Standard Zip Outrigger Release Clip
COK-0001T-2	Premium Outrigger Release Clip
COK-0004G-2	Outrigger Glass Rings
COK-0008B-1*	Black Dacron 1/8" Line, 100'
COK-0017-2	Outrigger Line Ball Stops, 1-1/4"
COK-0018-2	Outrigger Line Ball Stops, 1-3/4"
COK-0020-2	Shock Cord w/Single Pulley, 12"
COK-0021-2	Glass Eye w/Shock Cord, 12"
COK-0022-2	Shock Cord w/Double Pulley, 12"
COK-0024*	Outrigger Carry Bag, Black, 74" x 12"
COK-0043-1*	Triple Roller w/Shock Cord Pulley, 16"
F16-1200-2▼	Stainless Steel Eye Straps
F40-0030BKA-1	Outrigger Line Caddy for 1-1/8" & 1-1/2" Poles

* Sold in Bulk Only *Sold as Each ▼Sold in 4's



ROD HOLDERS

Clamp-On Adjustable Rod Holders



PRODUCT KNOWLEDGE



F16-2600 / F16-2623 /
F16-2630
Rotate and lock every 18°.

Stainless Steel or Plastic

- > Adjustable clamp fits multiple pipe/tube sizes
- > For use on vertical and horizontal pipe/tube
- > Rotate and lock-in fishing angle

Patent Pending

INCLUDES
FORM-FITTED
PVC ANTI-FUNGAL
WHITE LINER &
WHITE INSERT



F16-2623



F41-2700

INCLUDES
BLACK CLAMP
INSERT

Part #	Clamp Fits OD	Location	RH ID	Finish/Color
Stainless Steel Type 316				
F16-2600POL-1	7/8" & 1" OD (Tube)	Bow Rail, Grab Rail	1-5/8"	Polished
F16-2623POL-1	1-1/16" & 1-5/16" OD (Pipe), 1-1/4" OD (Tube)	T-Top, Leaning Post, Poling Platform	1-5/8"	Polished
F16-2630POL-1	1-11/16" & 1-15/16" OD (Pipe)	T-Top, Leaning Post, Poling Platform	1-5/8"	Polished
Plastic				
F41-2700WHA-1	7/8" & 1" OD (Tube)	Bow Rail	1-3/4"	White

Aluminum Rod Holder



Brite Anodized Aluminum

- > Ideal for welding to tower, t-tops, radar arches, railings and leaning posts
- > Flared style with scalloped blade

INCLUDES
FORM-FITTED
PVC ANTI-FUNGAL
BLACK LINER



Part #	Description	Length	Rod Holder ID
F31-2320BXY-4	Aluminum Rod Holder w/Scalloped Blade	10-1/4"	1-7/8"

Surface Mount Rod Holders



High-Density Polyethylene

Stand-Off Mount

- > Front access hole
- > Easy mounting

Thru-Bolt Mount

- > Front access hole
- > Pre-drilled mounting holes



Stand-Off Mount

Thru-Bolt Mount

Part #	Description	Rod Holder ID
P04-091B♦	Poly Stand-Off Rod Holder, Black	1-3/4"
P04-091W♦	Poly Stand-Off Rod Holder, White	1-3/4"
P04-0111W*	Poly Stand-Off Rod Holder w/Stainless Steel Hardware	1-3/4"
P04-011BX*	Poly Thru-Bolt Rod Holder w/Mounting Holes, Black	1-3/4"
P04-011W*	Poly Thru-Bolt Rod Holder w/Mounting Holes, White	1-3/4"

♦Standard pack 24 *Standard pack 27



Rod Hanger 3



High Polished Stainless Steel Type 316 w/High-Density Polyethylene

- > Spring locking rod tip holder
- > Delrin inserts
- > Concealed installation screws

Rod Hanger Rack

- > Three sizes for convenient 2-, 3- & 4-rod storage
- > Pre-drilled mounting holes and beveled edges
- > Mount vertically, horizontally or overhead

Patent #7,228,655

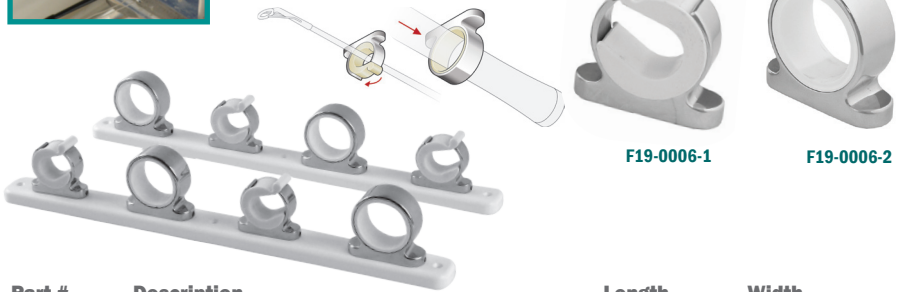

Part #	Description	Length	Width
F19-0006-1	Revolving Rod Tip Holder	2-1/4"	1"
F19-0006-2	Stationary Rod Hanger	2-3/4"	1"
F16-2700-1	Revolving Rod Tip Holder & Stationary Rod Hanger Kit	-	1"
F16-2751-1	2-Rod Hanger w/Poly Rack	9-1/8"	1-1/2"
F16-2752-1	4-Rod Hanger w/Poly Rack	18"	1-1/2"
F16-2753-1	3-Rod Hanger w/Poly Rack	13-1/2"	1-1/2"

Reel Hanger 3

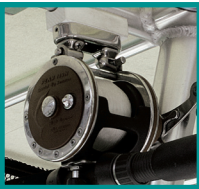

Stainless Steel Type 316

- > Corrosion-resistant, Stainless Steel spring secures reel into position
- > Adjustable to fit most popular trolling reels

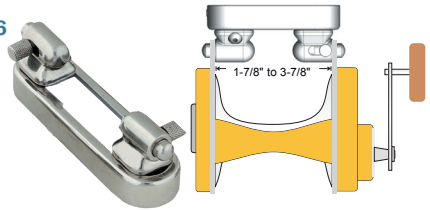

Part #	Description	Adjustment
F16-2810	Reel Hanger	1-7/8" - 3-7/8"

Convenient Kit for Rod & Reel Hangers

F16-2700-1

Revolving Rod Tip Holder & Stationary Rod Hanger Kit
Footprint: 2-3/4" x 1"

F16-2810-1

Reel Hanger w/Rod Tip Holder Kit
Adjusts: 1-7/8" - 3-7/8"



F16-2700-1

F16-2810-1



ROD STORAGE

Olympic 5-Rod Cluster 3



Polished Aluminum

- > Ergonomic, finger molded groove design for comfort grip
- > Solid gimbal mount design assures proper locking placement

PRODUCT KNOWLEDGE

IM

Finger molded groove handle for sure grip.



INCLUDES FORM-FITTED PVC ANTI-FUNGAL WHITE LINER



Solid gimbal design for secure locking placement and additional strength



Part #	Height	Width	Rod Holder Height	Rod Holder ID
F31-0790BXY-1	26"	13-1/2"	9-3/4"	1-3/4"

Kite Fishing Rod Cluster 3



Brushed Anodized Aluminum

- > 15° bent shaft for clearance
- > Fits all standard gunnel mount rod holders
- > Gimbal mount design assures proper locking placement

INCLUDES FORM-FITTED PVC ANTI-FUNGAL WHITE LINER



Part #	Height	Rod Holder Height	Rod Holder ID
F31-0770BSA-1	24-1/2"	9-3/4"	1-3/4"



Rod Rack Aluminum

3



Brite Brushed Aluminum

- > Drilled for #12 screws
- > Concealed fasteners
- > Available in 3- & 4-Rod Storage

INCLUDES
FORM-FITTED
PVC ANTI-FUNGAL
BLACK LINER



Part #	Description	Height	Width	Rod Holder ID
F31-3003BSA-1	3-Rod Holder Rack	8-1/2"	11-1/4"	1-1/2"
F31-3004BSA-1	4-Rod Holder Rack	8-1/2"	16"	1-1/2"

Rod Rack Aluminum w/Poly

3



Brite Brushed Aluminum w/High-Density Polyethylene

- > Drilled for #12 screws
- > Concealed fasteners
- > Features convenient integrated slots for knife and pliers
- > Available in 3- & 4-Rod Storage

INCLUDES
FORM-FITTED
PVC ANTI-FUNGAL
WHITE LINER



Part #	Description	Height	Width	Rod Holder ID
F31-3103BXZ	3-Rod Holder Rack, Aluminum w/Poly	8-1/2"	11-1/4"	1-1/2"
F31-3104BXZ	4-Rod Holder Rack, Aluminum w/Poly	8-1/2"	16"	1-1/2"



ROD STORAGE

Trident 3-Rod Cluster 3



High Polished Aluminum

- > Detachable tackle tray (also sold separately P01-3000W) includes cup holder
- > Tube OD 1-1/2" fits into standard Rod Holder ID 1-5/8"
- > Solid gimbal mount design assures proper locking placement

INCLUDES
FORM-FITTED PVC
ANTI-FUNGAL
WHITE LINER

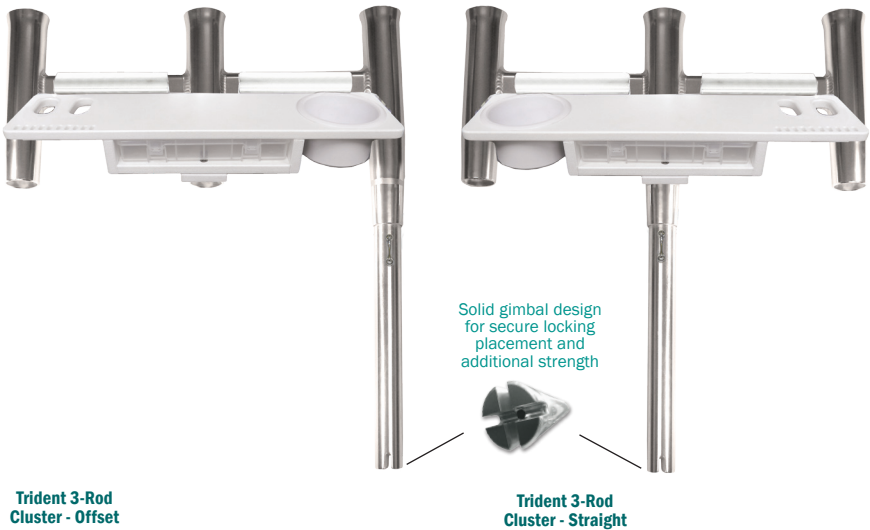

Trident 3-Rod Cluster - Offset

Trident 3-Rod Cluster - Straight

Part #	Description	Height	Width	Rod Holder Height	Rod Holder ID
F31-0780BXY-1	Trident 3-Rod Cluster Straight	24-7/8"	22-3/8"	9-3/4"	1-3/4"
F31-0781BXY-1	Trident 3-Rod Cluster Offset	25-1/2"	22-3/8"	9-3/4"	1-3/4"

Also Sold Separately - Turn to page 41 for more information

P01-3000W
Detachable Trident Tool Caddy



Transom Mount Rod Rack **3**



Brushed Anodized Aluminum

- > Patent-pending spline adjustments for rod holder angle and rack to fit the contour of the transom
- > Available in 3- & 4-Rod Storage

**INCLUDES
FORM-FITTED
PVC ANTI-FUNGAL
WHITE LINER**



PRODUCT KNOWLEDGE



Adjustable angle

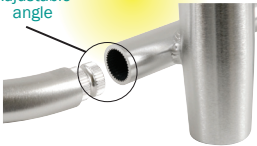

Adjust mounting angle to match transom contour and for rod holder positioning.

Part #	Description	"A"	Height	Rod Holder ID
F31-3503BSA-1	3-Rod Transom Mount Rack	34"	10"	1-7/8"
F31-3504BSA-1	4-Rod Transom Mount Rack	40-1/2"	10"	1-7/8"



ROD STORAGE

Rod & Reel Tote'm Rack



High-Density Polyethylene

- > Carries up to four conventional rods and reels
- > Compact design
- > Easy and light weight
- > Mounts vertical or horizontal using supplied mounting bracket with secure pin

Patent #6,267,425

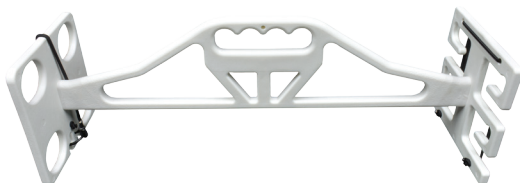

Part #	Description	Length	Depth	Color
P03-144W	Rod & Reel Tote'm Rack	18-5/8"	7-1/2"	White

Deluxe Rod Rack



High-Density Polyethylene

- > Withstands harsh marine environment
- > Flared rod holder for easy rod handling
- > Slotted rod holders lock in most conventional and spinning outfits
- > Features convenient integrated slots for knife and pliers
- > Available in 2-, 3- & 4-rod storage sizes



Tools not included

Part #	Description	"A"	"B"	Rod Holder ID	Color
P03-062B	2-Rod Poly Rod Rack	11-1/2"	6-1/2"	1-3/4"	Black
P03-062W	2-Rod Poly Rod Rack	11-1/2"	6-1/2"	1-3/4"	White
P03-063B	3-Rod Poly Rod Rack	18"	6-1/2"	1-3/4"	Black
P03-063W	3-Rod Poly Rod Rack	18"	6-1/2"	1-3/4"	White
P03-064B	4-Rod Poly Rod Rack	18"	4-1/2"	1-3/4"	Black
P03-064W	4-Rod Poly Rod Rack	18"	4-1/2"	1-3/4"	White



Deluxe Pontoon Boat Tackle Rack



High-Density Polyethylene

- > Stainless Steel fasteners resist rust and corrosion
- > Compact design is big enough to hold spinning and conventional tackle
- > Secure and convenient on-board rod storage
- > Easy assembly



Part #	Description	Length	Depth	Color
P03-073W	3-Rod Deluxe Pontoon Rack	17-1/2"	4"	White
P03-074W	4-Rod Deluxe Pontoon Rack	23-1/4"	4"	White

Bungee Rod Holder



High-Density Polyethylene

- > Perfect for under the gunnel
- > Bungee cords keep your rods safe and secure
- > Includes mounting backing plates and hardware for easy installation

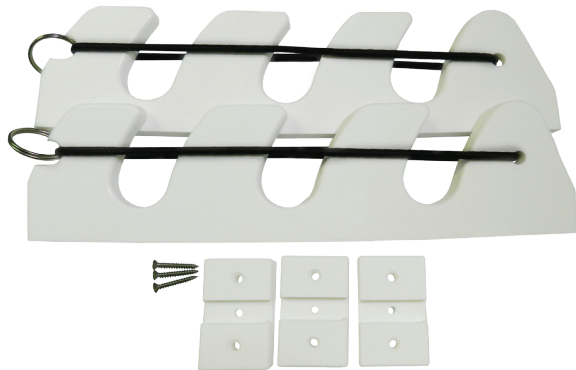

Part #	Description	Length	Depth	Thick	Color
P03-132W	2-Rod "Bungee" Rod Holder	9-1/4"	3-3/4"	1/2"	White
P03-133W	3-Rod "Bungee" Rod Holder	12-1/2"	3-3/4"	1/2"	White
P03-134W	4-Rod "Bungee" Rod Holder	15-5/8"	3-3/4"	1/2"	White



DOCKSIDE PRODUCTS

Shore Power Cable Holder



Stainless Steel Type 304

- > Tube OD 1-1/2" fits into standard Rod Holder ID 1-5/8"
- > Adjustable height, clamp-on ring for low and high tide
- > Accepts 30, 50, 100 shore power cables
- > Gimbal mount design assures proper locking placement
- > Packaged in mesh bag for quick drying and protection

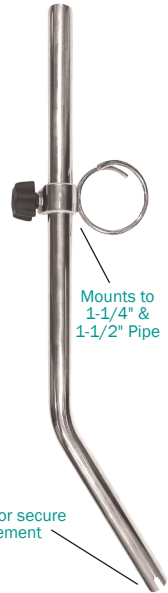

Gimbal design for secure locking placement

Part #	Description	Height	Width w/ Ring
F16-0802-1	Shore Power Cable Holder w/Ring	29"	4"

Also Sold Separately - Turn to page 41 for more information

F16-0804-1

Shore Power Cable Holder Ring only



Portable Multi Purpose 15° Cleat



Brushed Aluminum

- > Tube OD 1-1/2" fits into standard Rod Holder ID 1-5/8"
- > Accommodates up to 3/4" dock line for large boat applications
- > Allows for simultaneous use of dock line and fender
- > Gimbal mount design assures proper locking placement



Part #	Description	Height	Width
F30-0861BSA-1	Multi Purpose 15° Portable Cleat	14-1/2"	9"



Portable Locking Transom Cross Tie 15° Cleat



Brushed Aluminum

- > Large S-shape 9" cleat
- > Pipe diameter 1-1/2" fits into standard rod holders 1-5/8" diameter
- > Patent pending latching mechanism holds into rod holder
- > Accommodates up to 3/4" dock line for large boat applications
- > Loop hole design allows multiple applications
- > Ideal for elevated cross tie of lines
- > Reusable mesh bag ideal for quick drying and for avoiding scratches on deck or storage surfaces
- > Not intended for permanent docking



PRODUCT KNOWLEDGE



Patent pending latch mechanism securely holds into rod holder.

Part #	Height	Width	Tube OD	Hole ID
F30-0862BSA-1	30"	9"	1-1/2"	1-1/4"

Quick Release Fender Lock



Stainless Steel Type 316

- > Designed for single hand operation
- > Will allow easy installation and removal of float style fenders
- > Large push-button for comfortable operation
- > Large .88 hole diameter for rope
- > Overall height above deck: 1-19/32"
- > Drain plug: 1/4"
- > Quick and easy installation using 3/4" drill bit through gunnel
- > Quick Release Fender Lock Receiver only also sold separately as F16-0151R-1



Part #	Height	Width	Rod Holder Height	Rod Holder ID
F31-0790BXY-1	26"	13-1/2"	9-3/4"	1-3/4"

Also Sold Separately - Turn to page 41 for more information

F16-0151R-1

Quick Release Fender Lock Receiver only



DOCKSIDE PRODUCTS

Come On Board Handle



Stainless Steel Type 304

- > Tube OD 1-1/2" fits into standard Rod Holder ID 1-5/8" (F16-0810)
- > Finger molded groove handle design for comfort grip
- > Available as Fixed Base with receiver (receiver also sold separately) or Rod Holder Gunnel Mount
- > Additional receivers can be used for other desired boarding locations
- > Rod Holder Gunnel with solid gimbal mount design assures proper locking placement
- > Packaged in mesh bag for quick drying and protection

PRODUCT KNOWLEDGE

TM

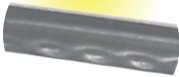

Finger molded groove handle for sure grip.



F16-0800



F16-0810

Solid gimbal design for secure locking placement and additional strength

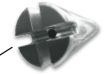

Part #	Description	Height	Width (Top)
F16-0800-1	Come On Board Handle, Fixed Base Mount w/Receiver	56-1/4"	11-5/8"
F16-0810-1	Come On Board Handle, Rod Holder Mount	57-1/2"	11-5/8"

Also Sold Separately - Turn to page 41 for more information

F16-0800C-1

Come On Board Handle,
Fixed Base Mount Receiver only



Dockside Filet Table



High Density Polyethylene w/Brushed Anodized Aluminum Frame

- > FDA-approved
- > Permanently mounts on dockside
- > Six 3/8" x 2-1/2" lag bolts secure each leg to the dock
- > Water nozzle holder for convenient use and clean-up
- > Drink holder mounts to the side
- > Filet knife and plier holder slots
- > Mounting hardware included



> Holds up to 250lbs.

Part #	Description	Height	Width	Depth
P01-4821W	Dockside Filet Table	38-1/2"	47-1/2"	21"

Adjustable Filet Table



High Density Polyethylene w/Brushed Anodized Aluminum Mount

- > Includes Stainless Steel fasteners
- > Slotted for knife and plier holder and drainage
- > Rugged engineered Nylon, adjustable tilt mount
- > Gimbal mount design assures proper locking placement
- > Folds flat for storage
- > Fits into any rod holder mount
- > Mount locks at any angle



Part #	Description	Height	Width	Depth
P01-2120W	Adjustable Poly Filet Table, 20"	15"	20"	12"
P01-2132W	Adjustable Poly Filet Table, 32"	15"	32"	12"

Big Game Poly Rod Storage Cart



High-Density Polyethylene

- > Wash rods while in rack
- > Use indoor or outdoor
- > Locking casters offer easy mobility
- > Ideal for large spinning and conventional reels



Part #	Description	Height	Width	Depth
R10-0514103	Big Game Poly Rod Storage Cart	33-1/4"	33-3/4"	12"



POLY PRODUCTS

Tumbler Holders



High-Density Polyethylene

- > Thick, 3/8" Starboard Polymer
- > Holds tumbler at proper height to prevent tipping
- > Single holder holds 16 to 30 oz. tumbler; double holder holds 2-16 to 30 oz. tumblers
- > Includes mobile device cutout and charging cable port
- > Drain holes on recessed bottom areas
- > Available in either Black or White Polymer
- > Includes large suction cups
- > Can be fix mounted



P01-2010



Patent Pending

Tumbler & phone
not included

P01-2020

Part #	Description	Height	Width	Depth
P01-2010B	1-Tumbler Poly Holder, Black	5-5/8"	4-7/8"	5-1/4"
P01-2020B	2-Tumbler Poly Holder, Black	5-3/8"	9-1/2"	5-5/8"
P01-2010W	1-Tumbler Poly Holder, White	5-5/8"	4-7/8"	5-1/4"
P01-2020W	2-Tumbler Poly Holder, White	5-3/8"	9-1/2"	5-5/8"

Drink Holders



High-Density Polyethylene

- > Holds full-sized insulated drink holders and mugs
- > Stainless Steel mounting screws for flat or bulkhead mount included
- > Suction cups included



P01-2000



P01-2001



P01-2003

Part #	Description	Height	Width	Depth
P01-2000W	2-Drink Poly Holder "Catch-All"	3-1/8"	16-3/8"	5-1/2"
P01-2001W	2-Drink Poly Holder w/Suction Cup Mount	3-5/8"	10"	4-7/8"
P01-2003W	1-Drink Poly Holder w/Suction Cup Mount	3"	4-5/8"	4-5/8"



Knife & Fishing Plier Holders



High-Density Polyethylene

- > Safe and convenient storage
- > Includes Stainless Steel mounting screws

Tools not included



P01-1000



P01-1001

Part #	Description	Color
P01-1000W	Knife & Plier Holder	White
P01-1001W	Knife, Plier & 15-Rig Holder	White

Rigging Strip



High-Density Polyethylene

- > Stores pre-rigs, plugs and spoons
- > 12" rig strip for any flat surface
- > Pre-drilled holes
- > Includes marine grade self-adhesive tape



Lures not included



Part #	Description	Color
P01-1200W	Adhesive Mount Rigging Strip	White

Trailer Glyde Slicks



High-Density Polyethylene

- > Eliminates friction between the bottom of the boat and the runners
- > Easy to install on carpeted or bare bunks
- > Evenly distributes the weight of the boat
- > Includes Stainless Steel screws
- > P05-06W ideal for under 600lb boats, P06-06W ideal for up to 2000lb boats



P05-06W



P06-06W

Part #	Description	Length	Width	Thick
P05-06W	6Pc. 2' Trailer Glyde Slicks	2'	1-5/8"	7/16"
P06-06W	6Pc. 2' Premium Trailer Glyde Slicks	2'	1-1/2"	7/16"



LED LIGHTS

LED Deck Lights



- > Anodized Aluminum heatsink
 - > High impact, UV-resistant and light weight
 - > 55 Watt Halogen flood light
 - > 100° spread beam angle
 - > 8' hidden power cable
 - > USCG, ISO and SAE certified for Ignition Protection*
 - > Available in 4-White, 3-Blue or 3-Red LED light
 - > Durable and self-extinguishing clear plastic lens
 - > LED chips are silicone potted for IP67 Waterproof (non-submersion)
- Flat Mount Polycarbonate Housing (Black or White)**
- > 3-LED: 8.0 Watt, 12-24V DC, 4-LED: 10.0 Watt, 12-24V DC

PRODUCT KNOWLEDGE



Stainless Steel Type 304 swivel bracket with 60° pivoting rotation.



- > 3-LED: 540 lumen output, 4-LED: 700 lumen output
 - > Includes Stainless Steel Type 304 swivel bracket
- Pipe Mount Aluminum Housing**
- > 3-LED: 8.0 Watt, 12-24V DC, 4-LED: 10.0 Watt, 12-24V DC
 - > 3-LED: 540 lumen output, 4-LED: 700 lumen output

Part #	Description	Lumens	Amperes Draw	Length	Width	Depth
F38-8500W-1	Deck Light, Flat Mount, White LED	540	.6 @ 12V	5"	1-11/32"	1/2"
F38-8500B-1	Deck Light, Flat Mount, Blue LED	540	.6 @ 12V	5"	1-11/32"	1/2"
F38-8500R-1	Deck Light, Flat Mount, Red LED	540	.6 @ 12V	5"	1-11/32"	1/2"
F38-8800BXZ-W-1	Deck Light, Pipe Mount, White LED	700	.6 @ 12V	5-1/2"	1-5/8"	1/2"
F38-8600BXZ-B-1	Deck Light, Pipe Mount, Blue LED	540	.6 @ 12V	5-1/2"	1-5/8"	1/2"
F38-8600BXZ-R-1	Deck Light, Pipe Mount, Red LED	540	.6 @ 12V	5-1/2"	1-5/8"	1/2"

*Completely sealed lights have been tested in an explosive environment and exposed to an explosive atmosphere in high temperature that includes powering on-off 50 times without igniting the atmosphere at a temperature not exceeding 200° C. These certificates demonstrate the ability to consistently provide product that meets statutory and regulatory requirements that assure customer satisfaction and safety. Ideal for use in engine rooms, battery compartments and anywhere fire safety is of most importance.

LED Spreader Light



- > 12-28Volt AC/DC
- > High 675 lumen output
- > Six (6) high-powered 1-Watt LEDs
- > IP67 Waterproof (non-submersible)
- > Wide 150° light spread
- > Adjustable Stainless Steel mounting bracket with adjustable tilt
- > UV- and impact-resistant White housing and polycarbonate lens

PRODUCT KNOWLEDGE



Includes Clamps for Standard 3/4" - 1" I.P.S. T-Top Ring (1-1/16" & 1-5/16" OD (OD) Pipe).



Part #	Description	Lumens	Amperes Draw	Height	Width	Depth
F38-4600WHA-1	Spreader Light	675	0.5	3-7/16"	5"	2-3/16"



LED T-Top Light, Pipe Mount



- > 8.0 Watt per section, 24 Watt total
- > 12-24V DC
- > Compact design bolts directly to 1" IPS pipe
- > White light has powerful 1080 lumen output with 100° spread beam angle
- > Red or Blue light 540 lumen output
- > Requires On-Off-On switch for proper operation
- > Very low power consumption (1.8 amps @ 12V)
- > 14' hidden power cable
- > Able to switch from White light to Blue or to Red light
- > Bright dip anodized Aluminum housing
- > Durable and self-extinguishing clear plastic lense

> LED chips are silicone potted for IP67 waterproof

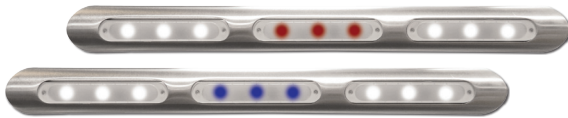

Part #	Description	Lumens	Amperes		Height	Width	Depth
			Draw				
F38-9600BXZ-B-1	T-Top Light, Pipe Mount, Blue/White LED	540/1080	1.8 @ 12V		1-5/8"	16-1/4"	1/2"
F38-9600BXZ-R-1	T-Top Light, Pipe Mount, Red/White LED	540/1080	1.8 @ 12V		1-5/8"	16-1/4"	1/2"

**Completely sealed lights have been tested in an explosive environment and exposed to an explosive atmosphere in high temperature that includes powering on-off 50 times without igniting the atmosphere at a temperature not exceeding 200° C. These certificates demonstrate the ability to consistently provide product that meets statutory and regulatory requirements that assure customer satisfaction and safety. Ideal for use in engine rooms, battery compartments and anywhere fire safety is of most importance.*

LED T-Top Tube Lights



- > Anodized Aluminum housing
- > 12-24V DC
- > 108 LEDs
- > 14' wiring cable
- > IP67 Waterproof
- LED T-Top Replacement Tube Light**
- > 12-24V DC
- > 108 LEDs
- > 14' wiring cable
- > Includes mounting clips for easy attachment
- > Fits most existing T-top light housing

> Switch from White to Red light or White to Blue light

> IP67 Waterproof

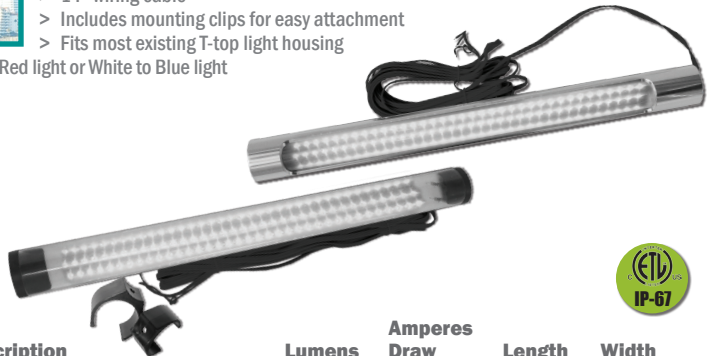

Part #	Description	Lumens	Amperes		Length	Width
			Draw			
F38-2050B-1	T-Top Light w/Housing, Blue/White LED	300	< .18		20"	1-39/64"
F38-2050R-1	T-Top Light w/Housing, Red/White LED	300	< .18		20"	1-39/64"
F38-2060B-1	T-Top Tube Light, Blue/White LED	300	< .18		20"	1-39/64"
F38-2060R-1	T-Top Tube Light, Red/White LED	300	< .18		20"	1-39/64"



LED LIGHTS

Rub Rail Mounted LED Navigation Light Sets

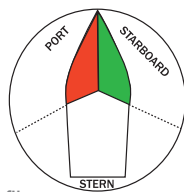

Stainless Steel Type 304

High Polished Finish

- > ABYC/USCG approved
- > Aluminum heat sink
- > 3-Watt Port (Red) and Starboard (Green) LEDs
- > IP68 rating for "wet locations"
- > Designed to fit several TACO Marine Rigid Vinyl Rub Rail profiles
- > 120° unobstructed view
- > Two-mile range
- > Reliable long-life LEDs will provide years of maintenance-free service
- > Easy installation

> F38-6600 ideal for up to 30' boats, F38-6700 ideal for up to 38' boats

PRODUCT KNOWLEDGE

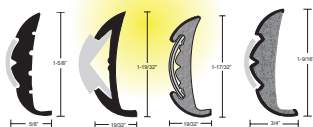

Fits TACO Marine
V21-9659,
V21-9904,
V21-9909, and
V21-9959
Rigid Vinyl Rub Rail

PRODUCT KNOWLEDGE



Fits TACO Marine
V21-9906
Rigid Vinyl Rub Rail



Patent Pending

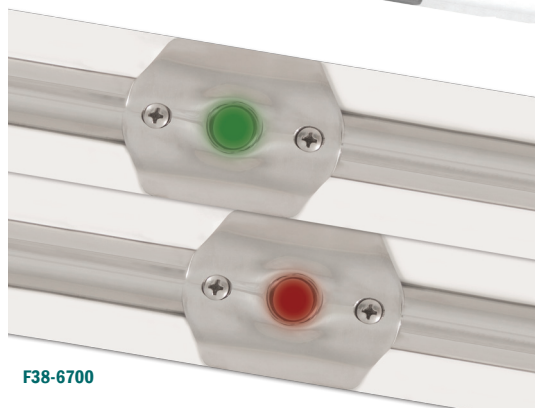

F38-6700



Part #	Description	Voltage	Amperes			
			Draw	Height	Width	Depth
F38-6600-1	Rub Rail Mounted Navigation Lights	12-24V DC	< 0.25	1-3/4"	3"	1-3/4"
F38-6700-1	Rub Rail Mounted Navigation Lights, Large	12-24V DC	< 0.25	2-5/32"	2-37/74"	1-3/4"



800.653.8568

info@tacomarine.com

Rub Rail Insert Mounted LED Navigation Light Set



Stainless Steel Type 316

High Polished Finish

Insert Mount Set

- > Easy installation with both Vinyl and Stainless Steel inserts
- > Designed to fit TACO Marine's popular Rub Rails that take 3/4" insert
- > Ideal for up to 30' boats



F38-6800



F38-6800C-1 (w/o Plug)



F38-6800C-2 (w/Plug)

Surface Mounted LED Navigation Light Set

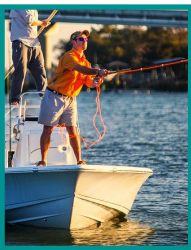

Stainless Steel Type 316

High Polished Finish

Surface Side Mount Set

- > Easy installation with marine adhesive sealants
- > Low profile round navigation light set (Red and Green) designed to mount on both sides of cabin or hard top for clear, elevated visibility
- > Available with or without plug
- > Ideal for up to 40' boats

Surface Stern Mount Set

- > Easy installation with marine adhesive sealants
- > Low profile round navigation White light designed to mount on transom area of boat

- > Available with or without plug
- > Ideal for up to 40' boats



F38-6100 / F38-6610



Surface Mount w/o Plug



Surface Mount w/Plug

Part #	Description	Height	Width	Depth	Amperes	Draw
F38-6800C-1∞	Rub Rail Mounted Navigation Light Set, w/o Plug	3/4"	2-1/2"	5/16"	.6 @	12V
F38-6800C-2∞	Rub Rail Mounted Navigation Light Set, w/Plug	3/4"	2-1/2"	5/16"	.6 @	12V
F38-6610C-1∞	Surface Mount Side Light Set, w/o Plug	1-1/4"	1-1/4"	1/4"	.6 @	12V
F38-6610C-2∞	Surface Mount Side Light Set, w/Plug	1-1/4"	1-1/4"	1/4"	.6 @	12V
F38-6100C-1∞	Surface Mount Stern Light Single, w/o Plug	1-1/4"	1-1/4"	1/4"	.6 @	12V
F38-6100C-2∞	Surface Mount Stern Light Single, w/Plug	1-1/4"	1-1/4"	1/4"	.6 @	12V

∞Special Order



SEATING

Capri Helm Chair "Deluxe"



Stainless Steel Type 316 (Armrest Brackets & Roll-Back Seat Hinge w/Protective Cover)

- > Includes adjustable armrests and bolster (except for 23" chair)
- > Stainless Steel roll-back seat hinge with shield protector
- > Premium quality marine-grade vinyl fabric treated with anti-microbial and UV stabilizers
- > Plush foam padding provides durable support
- > Flexible, ergonomic design
- > Meets ABYC H-31 impact test
- > Durable fiberglass seat back
- > Roll-back seat bolster for quick repositioning and helm access
- > Colors available are Light Gray, Vanilla, White and Black
- > Custom vinyl options available for boat builders

> Ideal for 25' - 50' boats



All chairs come with durable, fiberglass seat back.

Custom vinyl options available.



COLOR GUIDE*

Lt. Gray

Vanilla

White

Black

Part #	Description	"A"	"B"	"C"
Chair (23" does not include armrest)				
HA2-23GRA-7-0000-0-0	23" Helm Chair, Lt. Gray	23"	21"	24"
HA2-23IVA-7-0000-0-0	23" Helm Chair, Vanilla	23"	21"	24"
HA2-23WHA-7-0000-0-0	23" Helm Chair, White	23"	21"	24"
HA2-23BKA-7-0000-0-0	23" Helm Chair, Black	23"	21"	24"
HA1-25GRA-7-0000-0-0	25" Helm Chair, Lt. Gray	25"	21"	25"
HA1-25IVA-7-0000-0-0	25" Helm Chair, Vanilla	25"	21"	25"
HA1-25WHA-7-0000-0-0	25" Helm Chair, White	25"	21"	25"
HA1-25BKA-7-0000-0-0	25" Helm Chair, Black	25"	21"	25"
HA1-28GRA-7-0000-0-0	28" Helm Chair, Lt. Gray	28"	21"	25"
HA1-28IVA-7-0000-0-0	28" Helm Chair, Vanilla	28"	21"	25"
HA1-28WHA-7-0000-0-0	28" Helm Chair, White	28"	21"	25"
HA1-28BKA-7-0000-0-0	28" Helm Chair, Black	28"	21"	25"
Bench				
HA1-36GRA-7-0000-0-0	36" Helm Chair, Lt. Gray	36"	21"	25"
HA1-36IVA-7-0000-0-0	36" Helm Chair, Vanilla	36"	21"	25"
HA1-36WHA-7-0000-0-0	36" Helm Chair, White	36"	21"	25"
HA1-36BKA-7-0000-0-0	36" Helm Chair, Black	36"	21"	25"
HA1-40GRA-7-0000-0-0	40" Helm Chair, Lt. Gray	40"	21"	25"
HA1-40IVA-7-0000-0-0	40" Helm Chair, Vanilla	40"	21"	25"
HA1-40WHA-7-0000-0-0	40" Helm Chair, White	40"	21"	25"
HA1-40BKA-7-0000-0-0	40" Helm Chair, Black	40"	21"	25"

*Due to variations in the printing process, color may vary slightly from the original product. Color samples available upon request.



Capri Helm Chair "Standard"



Stainless Steel Type 316 (Armrest Brackets)

- > Includes armrests with fixed seat bottom (except for 23" chair)
- > Premium quality marine-grade vinyl fabric treated with anti-microbial and UV stabilizers
- > Plush foam padding provides durable support
- > Flexible, ergonomic design
- > Meets ABYC H-31 impact test
- > Colors available are Light Gray, Vanilla, White and Black
- > Custom vinyl options available for boat builders
- > Ideal for 25' - 50' boats



Part #	Description	"A"	"B"	"C"
HA21-23GRA-0000-0-0	23" Helm Chair, Lt. Gray	23"	21"	24"
HA21-23IVA-0000-0-0	23" Helm Chair, Vanilla	23"	21"	24"
HA21-23WHA-0000-0-0	23" Helm Chair, White	23"	21"	24"
HA21-23BKA-0000-0-0	23" Helm Chair, Black	23"	21"	24"
HA11-25GRA-0000-0-0	25" Helm Chair, Lt. Gray	25"	21"	25"
HA11-25IVA-0000-0-0	25" Helm Chair, Vanilla	25"	21"	25"
HA11-25WHA-0000-0-0	25" Helm Chair, White	25"	21"	25"
HA11-25BKA-0000-0-0	25" Helm Chair, Black	25"	21"	25"
HA11-28GRA-0000-0-0	28" Helm Chair, Lt. Gray	28"	21"	25"
HA11-28IVA-0000-0-0	28" Helm Chair, Vanilla	28"	21"	25"
HA11-28WHA-0000-0-0	28" Helm Chair, White	28"	21"	25"
HA11-28BKA-0000-0-0	28" Helm Chair, Black	28"	21"	25"

Also Sold Separately - Turn to page 38 for more information

M20-0225, M20-0226, M20-0227, M20-0228

Low Profile Seat Slide w/Handle



SEATING

Coastal Helm Chair



Stainless Steel Type 316 (Armrest Brackets & Roll-Back Seat Hinge w/Protective Cover)

- > Premium quality marine-grade vinyl fabrics treated with anti-microbial and UV stabilizers
- > Push foam padding provides durable support
- > Flexible, ergonomic design
- > Meets ABYC H-31 impact test
- > Roll-back seat bolster allows quick repositioning
- > Colors available are Amber Leaf, Cool Gray, Off White and Black
- > Custom vinyl options available for boat builders
- > Ideal for 20' - 25' boats

Deluxe

- > Includes fixed armrests and adjustable bolster seat

Standard

- > Made with fixed seat bottom and available with or without armrests



All chairs come with durable, fiberglass seat back.



Custom vinyl options available.



Standard



Deluxe

COLOR GUIDE*

Amber Leaf

Cool Gray

Off White

Black

Part #	Description	"A"	"B"	"C"
Deluxe				
HB10-20AML-0000-0-0	20" Coastal Chair, Amber Leaf	20"	21"	24-1/2"
HB10-20CGR-0000-0-0	20" Coastal Chair, Cool Gray	20"	21"	24-1/2"
HB10-200WH-0000-0-0	20" Coastal Chair, Off White	20"	21"	24-1/2"
HB10-20BKA-0000-0-0	20" Coastal Chair, Black	20"	21"	24-1/2"
Standard				
HB11-19AML-0000-0-0	19" Coastal Chair w/Armrests, Amber Leaf	19"	18-1/2"	24-1/2"
HB11-19CGR-0000-0-0	19" Coastal Chair w/Armrests, Cool Gray	19"	18-1/2"	24-1/2"
HB11-190WH-0000-0-0	19" Coastal Chair w/Armrests, Off White	19"	18-1/2"	24-1/2"
HB11-19BKA-0000-0-0	19" Coastal Chair w/Armrests, Black	19"	18-1/2"	24-1/2"
HB21-19AML-0000-0-0	19" Coastal Chair, Amber Leaf	19"	18-1/2"	24-1/2"
HB21-19CGR-0000-0-0	19" Coastal Chair, Cool Gray	19"	18-1/2"	24-1/2"
HB21-190WH-0000-0-0	19" Coastal Chair, Off White	19"	18-1/2"	24-1/2"
HB21-19BLK-0000-0-0	19" Coastal Chair, Black	19"	18-1/2"	24-1/2"

*Due to variations in the printing process, color may vary slightly from the original product. Color samples available upon request.



Captiva Helm Chair

**Stainless Steel Type 316 (Armrest Brackets & Roll-Back Seat Hinge w/Protective Cover)**

- > Ergonomic design for maximum comfort on long trips
- > Available in White
- > Durable marine grade components and materials
- > Built to meet H31 seat category requirement
- > 23" size allows multiple chairs side by side
- > Pleated inserts provide a stylish look
- > Folding armrests and hinged bolster pad standard features
- > Polished stainless hardware and non-wood construction
- > Matches with TACO Marine seat slide for easy adjustment
- > Custom two-tone options available: White base with color insets or color welt and piping



Part #	Description	"A"	"B"	"C"
HA3-23WHA-0000-0-0	23" Captiva Chair, White	23"	21"	23"

Also Sold Separately - Turn to page 38 for more information

M20-0225, M20-0226, M20-0227, M20-0228
Low Profile Seat Slide w/Handle



LEANING POSTS

Neptune III Leaning Post 3



Aluminum One-Piece Frame
Spiral Sanded, Bright Dip Anodized Finish

- > Includes Poly Rod Holders for L10-2005
- > Includes Aluminum Rod Holders for L10-2010
- > Seat cushions constructed with marine-grade vinyl, foam and PVC board substrate
- > Anti-warp and anti-rot
- > Mildew, fungus and UV-resistant
- > Folding footrest
- > Cooler storage area and strap
- > Shipping compliant packaging
- > Ideal for under 25' boats



L10-2010BSA-1



L10-2005BSA-1

Turn to page 45 for more information

Part #	Description	Height	Width	Depth
L10-2005BSA-1	Neptune III Leaning Post w/Smooth Upholstery	32"	35-1/2"	23"
L10-2010BSA-1	Neptune III Leaning Post w/Backrest, Grab Rail	45"	39"	24-1/2"

Also Sold Separately - Turn to page 38 for more information

L10-1004
Cooler Straps



Neptune II Leaning Post 3



Aluminum One-Piece Frame

Spiral Sanded, Bright Dip Anodized Finish

- > Includes Aluminum Rod Holders
- > Mildew, fungus and UV-resistant
- > Includes large capacity Neptune Tackle Storage Bag (also sold separately)
- > Folding footrest
- > Cooler storage area and strap
- > Footprint: 15" x 35"
- > Shipping compliant packaging
- > Ideal for under 25' boats



Dimensions Shown
with Closed Seat

Turn to page 45 for
more information

Part #	Description	Height	Width	Depth
L10-1003-1	Neptune II Leaning Post w/Removable Soft Pack Storage	32-1/2"	35"	26"

Also Sold Separately - Turn to page 38 & 39 for more information

- L10-1003BAG**
Neptune Tackle Storage Bag
- L10-1002-1**
Universal Backrest
- L10-1004**
Cooler Straps



L10-1003BAG



L10-1002-1



L10-1004



LEANING POSTS

Neptune Premium Leaning Post

3

Neptune Premium
TACO MARINE



Aluminum One-Piece Frame
Spiral Sanded, Bright Dip Anodized Finish

- > Includes flush-mounted Aluminum Rod Holders
- > Hand-laid fiberglass deck
- > Anodized after fabrication - no painted welds or crazing around bends
- > Mildew, fungus and UV-resistant
- > Removable storage tray
- > Folding footrest
- > Cooler storage area and strap
- > Shipping compliant packaging
- > Ideal for 22' - 30' boats



Dimensions Shown
with Closed Seat

Turn to page 45 for more information

Part #	Description	Height	Width	Depth
L10-1001-1	Neptune Premium Leaning Post w/Fiberglass Storage	33-1/2"	39"	27"

Also Sold Separately - Turn to page 38 & 39 for more information

L10-1002-1
Universal Backrest
L10-1004
Cooler Straps





ACCESSORIES

ACCESSORIES

Helm Chair Low Profile Seat Slide



- > Aluminum
- > Used on all TACO Marine Helm Chairs
- > Patented Delrin roller configuration
- > Patented double-locking side actuator
- > Operates up to 500lbs. total weight

Patent Pending

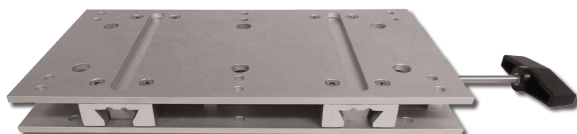

Part #	Description	Fits
M20-0225	Low Profile Seat Slide w/Short Handle	19", 20", 23" Helm Chair
M20-0226	Low Profile Seat Slide w/Long Handle	25", 28", 36" Helm Chair
M20-0227	Low Profile Seat Slide w/Short Handle, Pedestal Mount	Up to 28" Helm Chair
M20-0228	Low Profile Seat Slide, Bench Style	40" Helm Chair Bench

Cooler Strap



- > Black Nylon
- > Includes Stainless Steel brackets and screws



Part #	Length	Width
L10-1004	38"	2"



Neptune Leaning Post Tackle Storage Bag



- > 1000 Denier Carbon Grey fabric
- > Ballistic Black Nylon bottom liner with rubber feet and drain holes
- > YKK marine grade zipper
- > Outer and inner pockets
- > Large capacity interior compartment
- > 2" shoulder carrying strap



Plano compartment tackle trays used for photo; not sold by TACO Marine.

PRODUCT KNOWLEDGE
TM



Includes walt track clips for hanging on TACO Marine Neptune II Leaning Post.

Part #	Length	Interior Compartment Length	Height	Width
L10-1003BAG	30"	29"	10-1/4"	9-1/2"

Universal Backrest



- > Universal design to fit TACO Marine Neptune Premium and Neptune II Leaning Posts and other standard Leaning Posts
- > Arms install at desired width to fit rod holders
- > Cool, white, easy-to-clean, cushioned backrest
- > Arms fold for easy storage when not in use
- > Not recommended for plastic rod holders



Part #	Height	Width	Depth
L10-1002-1	7-3/8"	34"	3"



ACCESSORIES

Grand Slam Outrigger Mount Plates



Backing Plate

- > For additional support required when mounting to hard tops and gunnels
- > Sold in Pairs

Wedge Plate

- > Injection molded plastic wedge for use with curved T-top
- > Sold in Pairs

Extrusion Plate

- > Heavy-duty construction offered pre-drilled for easy mounting of Grand Slam 280 and 380 Outrigger Mounts
- > Conceals wiring
- > Sold in Pairs



BP-150



WP-150

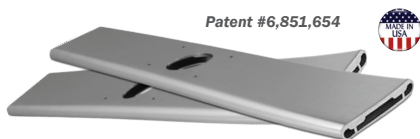

Patent #6,851,654



GSE-1939

Part #	Length	Width	Thickness	Finish / Color
BP150BSY-320-1	6-1/2"	5"	1/4"	320 Grit Brite Anodized
WP-150WHA-1	6"	4"	7.5°	White
GSE-1939BLS30	30"	5-1/8"	7/8"	Linear Sanded
GSE-1939BSA-20	20"	5-1/8"	7/8"	320 Grit Brite Anodized
GSE-1939BSA28-C	28"	5-1/8"	7/8"	320 Grit Brite Anodized

Striker Base Gunnel Mount Replacement Arm



Stainless Steel Type 316

- > Hex nut locking design
- > 45° arm
- > Sold as Each

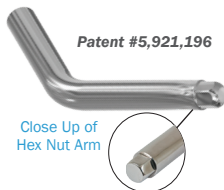

Patent #5,921,196

Close Up of
Hex Nut Arm

Part #	Description	Height	ID
M17-1465P-4	Replacement 45° Arm for F16-0212-F	15-1/2"	1-1/8"
M17-1565P-6	Replacement 45° Arm for F16-0150-F	15-1/2"	1-1/2"

Outrigger Line Caddy



- > Black Nylon with Stainless Steel hardware
- > Clamps to Outriggers to eliminate tangling and maintain rigging lines when Outriggers are retracted
- > Adjustable to fit both 1-1/8" and 1-1/2" Outrigger Poles
- > Sold in Pairs



Part #	ID	Color
F40-0030BKA-1	1-1/8" & 1-1/2"	Black

Base Reducer



- > Aluminum with Nylon outer sleeve
- > Reduces ID from 1-1/2" to 1-1/8" to accept 1-1/8" diameter outriggers
- > Sold in Pairs



Part #	ID	OD
GSC-0025-1	1-1/8"	1-1/2"



Come On Board Handle Fixed Base Mount Receiver



Stainless Steel Type 304

- > Includes backing plate
- > Interior white liner adds stability
- > Hardware not included



Part #	Height	Diameter
F16-0800C-1	3-1/2"	1-11/16"

Quick Release Fender Lock Receiver



Stainless Steel Type 316

- > Allows multiple fender locations on boat
- > Use in up to 2" thick gunnel



Part #	Height	Diameter
F16-0151R-1	2-5/8"	1-1/2"

Shore Power Cable Holder Adjustable Ring



Stainless Steel Type 304

- > Includes Delrin washer insert
- > Fits 1-1/4" to 1-1/2" tube diameter



Part #	Ring Width	OD
F16-0804-1	4"	1-1/4 or 1-1/2"

Trident Tool Caddy

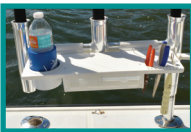

- > Starboard construction
- > High-density Polyethylene cup holder
- > Includes Plano 8 compartment tackle tray
- > Fits standard horizontal oval pipe

PRODUCT KNOWLEDGE

TM



Includes
Plano 8
compartment
tackle tray.

Lures not included



Part #	Width	Height	Depth
P01-3000W	18-1/2"	3"	4-1/2"

800.653.8568

info@tacomarine.com



TACO
MARINE



Rigging an Outrigger

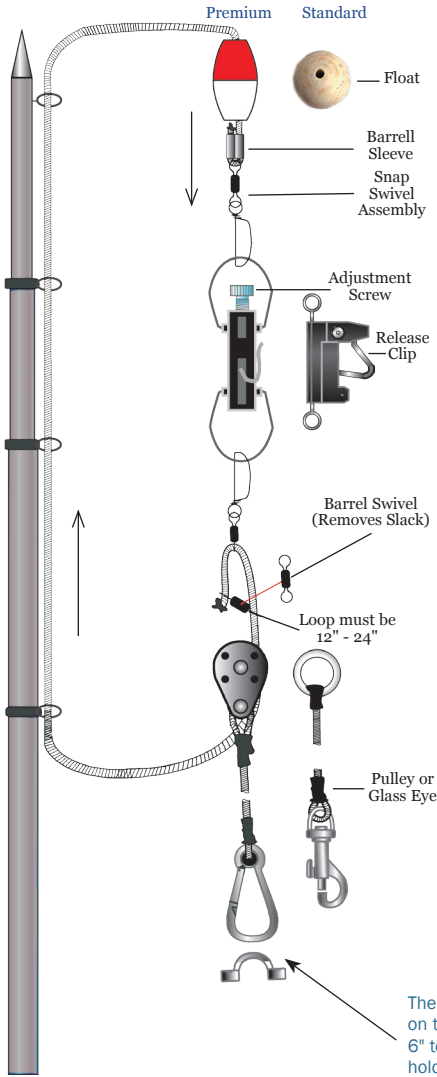

Single Rigging

- › Apply small amount of tape in middle of line bundles (to avoid frayed ends).
- › Cut the bundles of line into 2.
- › Run the outrigger line up through each of the eye guides from the bottom up to the very top eye.
- › Pass line through float and then through the barrel sleeve, through the snap swivel assembly and back through the barrel sleeve.
- › Tie a double knot and then attach the release clip to swivel assembly.
- › Using the other end of the line, run line through the pulley.
- › Run the line through the barrel swivel, through the snap swivel assembly and back through the barrel swivel.
- › Tie a figure 8 knot and adjust slack as needed. Attach swivel assembly to the release clip.
- › Secure pulley/bungee assembly to pad eye. Remove slack by sliding the lock swivel down and/or cut off excess line on the outside of locking swivel.

The pad eyes that the bungee hooks to on the gunwale is usually installed about 6" toward the stern between the outrigger holder and the rod holder. On the T-Top the pad eye is usually hooked on the outer t-top ring so it can be easily reached.

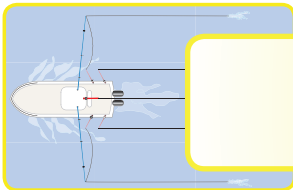



Double Rigging

- Apply small amount of tape in middle of line bundle (to avoid a frayed end).
- Cut the two bundles of line into 2.
- Run the outrigger line (1) up through each of the eye guides from the bottom up to the very top eye.
- Run top outrigger line (2) up to the 2nd from the end eye guide. Do the following for both lines (1&2):
 - Pass line through float and then through the barrel sleeve, through the snap swivel assembly and back through the barrel sleeve.
 - Tie a double knot and then attach the release clip to swivel assembly. (The adjustment screw on the release clip faces up.)
 - Using the other end of the line (1), run line through the pulley. Line (1) goes through the lower pulley while line (2) goes to the upper pulley.
 - Run each of the lines through the barrel swivel, through the snap swivel assembly and back through the barrel swivel.
 - Tie a figure 8 knot and adjust slack as needed. Attach swivel assembly to the lower release clip.
- Secure double pulley/bungee assembly to pad eye. Remove slack by sliding the lock swivel down and/or cut off excess line on the outside of locking swivel.

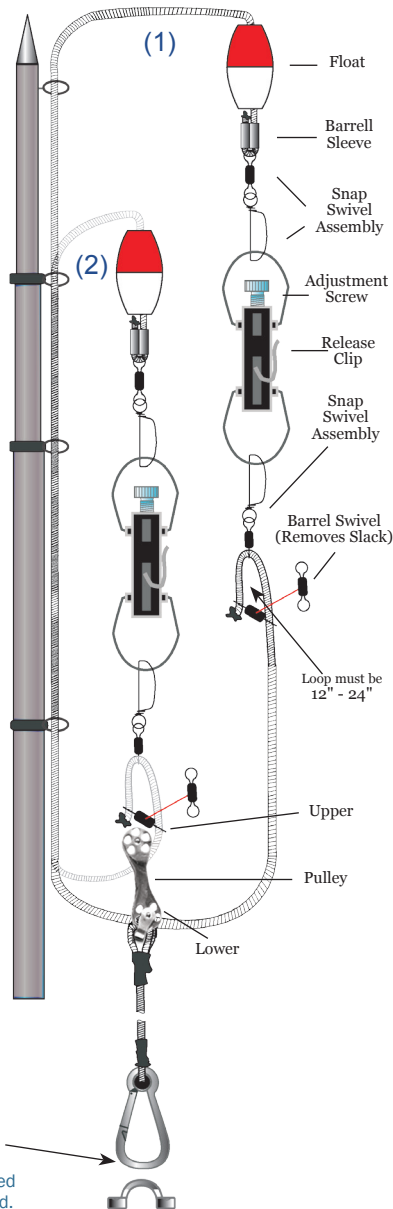

The pad eyes that the bungee hooks to on the gunwale is usually installed about 6" toward the stern between the outrigger holder and the rod holder. On the T-top, the pad eye is usually hooked on the outer T-top ring so it can be easily reached.

When trolling with outriggers you can troll with more lines in the water, thus pulling more bait which simulates a school of fish. Outriggers will eliminate tangled lines. Each outrigger can accommodate one or two lines from your rods and reels. The line is used with a release clip that extends to the end of your outrigger. When a fish strikes your bait, the release clip will allow your fishing line to come free of the outrigger so you can reel in the fish.





Grand Slam 280 & 380

Grand Slam 280 & 380 outrigger mounts are designed to work easily while standing at the console. The pull down rotator handle swings the outriggers into position and operates from under the top. The Grand Slam 280 & 380 can be mounted through an existing plate or to a newly installed plate.

- › The existing plate must be at least 4-1/2" x 5-1/2" x 3/8".
- › Drill a 3" center hole and 3/8" through bolt holes.

NOTE: If new mounting plates are needed, TACO Marine offers a weld on mounting plate, GSE-1939.

When installing a Grand Slam through canvas:

1. Cut an "X" over the 3" hole
2. Install and bolt down the Grand Slam then trim off the excess canvas

When installing a Grand Slam through a hard top frame:

1. TACO Marine backing plates should be used for extra support
2. When mounting through a core or foam filled top, spacers should be used in the bolt holes to prevent compression of the top when bolting.
NOTE: Mounting to a hard top that is hollow is not recommended, contact the boat manufacturer if the structural integrity of the top is questionable.
3. The maximum thickness allowable for the hard top is 2-7/8" for the GS-280 model. The GS-380XL is available for thicker hard tops up to 4-1/2".

TIP: For the GS-280, the center of the 3" hole should be at least 7-1/2" from the tubing of the canvas top frame, or any other object that may come in contact with the handle. For the GS-380, the center of the 3" hole should be at least 10" from the tubing of the canvas top frame, or any other object that may come in contact with the handle. Wedge plate available in 7.5° for tops that have an arch. For convenience purposes, a template is available online at TacoMarine.com to assist in the installation process.

Grand Slam 170

The affordable Grand Slam 170 is easy to install and use. A simple pull of the button swings the outrigger into fishing positions and also features a lay down arm for bridges and storage. The Grand Slam 170 can be mounted through an existing Grand Slam plate - a hard top that is a minimum 1/4" thick and is 4-1/2" in width and 5-1/2" in length. It only requires drilling the 4 bolt holes and using 5/16" bolt, nuts and washers.





TOOLS AND SUPPLIES NEEDED:

- › Phillips head screwdriver or a screw gun
- › Adjustable wrench
- › Wax pencil and a lead pencil
- › Electric or battery powered drill
- › Jig Saw
- › 5/32" Hex wrench (Included with Leaning Post)
- › 24" x 54" sheet of white marine lumber (P10-5024WHA54-1)

INSTALLATION

1. Before assembling the Leaning Post, check the footprint dimensions and mark the approximately locations of the mounting holes with a wax pencil.
2. Check underneath the deck to make sure that any gas tanks, gas lines, electrical wires, etc. are far enough below the deck so they will not be damaged when drilling or through bolting the Leaning Post to the deck. (Caution, if you do not know what is directly underneath your mounting location ask your boat manufacturer, a qualified boat mechanic, or use a flashlight to view the area through an existing access hole or make a hole in an area that you can properly seal and cover afterwards.).
3. Assemble the Leaning Post according to the Assembly Instructions provided.
4. Using the footprint of your Leaning Post, make backing plates out of a piece of 1/2" Marine Lumber. Make sure you leave enough material for a cover plate (Step 14).
5. If the area underneath is acceptable, place the Leaning Post in the desired location (about 12" from the console).
6. Make sure that your Leaning Post is straight and parallel with your console.
7. Mark the hole locations through the mounting holes in each mounting flange, making sure that the Leaning Post does not move.
8. Install a 3/16" drill bit into your drill and put a piece of tape on the drill bit 1" from the tip so you will know when to stop and do not drill too deep.
9. Drill the mounting holes.
10. Put the Leaning Post back in place to make sure that all the holes line up. Enlarge holes if necessary.
11. If you do not have an access hatch to the underside of the deck you will have to cut an access hole between the two mounting locations on each side of the leaning post big enough so you can reach inside and install a backing plate and locknuts or T-nuts on the mounting screws. Make sure that the access hole is completely within the mounting feet of the leaning post so that you can seal and cover it up with a piece of Marine Lumber after the installation.
12. Put sealant on the threads of each of the 1/4" mounting bolts and insert them into the holes.
13. Install the backing plates and locknuts or T-nuts on the mounting bolts through the access holes and tighten them securely.
14. Using a piece of 24" x 54" Marine Lumber (P10-5024WHA54-1) cut the cover plate to fit within the footprint of your Leaning Post.
15. Drill clearance holes in the Marine Lumber for the mounting screws.
16. Using the clearance holes mark the deck and drill pilot holes so the screws can thread into the deck.
17. Place Silicone sealant around each of the access holes and line up the holes in the Marine Lumber cover plate with the pilot holes, put sealant on the screw threads and install the screw to secure the cover plate to the deck
18. Install the optional cooler and adjust the straps



INDEX

A

Adjustable Filet Table.....	23
Aluminum Rod Holder.....	12

B

Big Game Poly Rod Storage Cart	23
Bungee Rod Holder.....	19

C

Capri Helm Chairs	30
Captiva Helm Chair	33
Carbon Fiber Center Rigger Poles.....	9
Carbon Fiber Tele-Outrigger Poles	9
Center Rigger Fixed Mount.....	6
Center Rigger Poles.....	8
Clamp-On Adjustable Rod Holders.....	12
Coastal Helm Chairs	32
Come On Board Handle	22
Come On Board Handle Fixed Base Mount Receiver	22,41

D

Deluxe Pontoon Boat Tackle Rack	19
Deluxe Rod Rack.....	18
Dockside Filet Table.....	23
Drink Holders	24

G

Grand Slam 170-2 Center Rigger Top Mount.....	5
Grand Slam 170 Outrigger Top Mount.....	5
Grand Slam 280 Outrigger Top Mount	4
Grand Slam 380 Outrigger Top Mount	3
Grand Slam 380XL Outrigger Top Mount	3
Grand Slam 890 Universal Mount	7
Grand Slam 2801 Outrigger Top Mount	4
Grand Slam Outrigger Mount Backing Plate	3,40
Grand Slam Outrigger Mount Extrusion Plate	3,40
Grand Slam Outrigger Mount Wedge Plate	3,40

H

Helm Chair Seat Slide.....	30-33,38
----------------------------	----------

K

Kite Fishing Rod Cluster	14
Knife & Fishing Plier Holders	25

L

LED Deck Light - Flat Mount.....	26
LED Deck Light - Pipe Mount.....	26
LED Spreader Light.....	26
LED T-top Light	27

LED T-top Tube Light	27
LED T-top Replacement Tube Light.....	27

N

Neptune III Leaning Post	34
Neptune II Leaning Post	35
Neptune Leaning Post Cooler Strap	34-36,38
Neptune Leaning Post Tackle Storage Bag.....	35,39
Neptune Leaning Post Universal Backrest.....	35-36,39
Neptune Premium Leaning Post.....	35

O

Olympic 5-Rod Cluster	14
Outrigger Base Reducer	40
Outrigger Line Caddy	4,5,8,9,40

P

Portable Locking Transom Cross Tie Cleat.....	21
Portable Multi Purpose Cleat	20

Q

Quick Release Fender Lock.....	21
Quick Release Fender Lock Receiver	21,41

R

Reel Hanger.....	13
Rigging Kit Components	11
Rigging Kits.....	10
Rigging Strip	25
Rod Hanger.....	13
Rod Hanger Rack	13
Rod Rack Aluminum	15
Rod Rack Aluminum w/Poly.....	15
Rod & Reel Tote'm Rack	18
Rub Rail Insert Mounted LED Navigation Light Set	29
Rub Rail Mounted LED Navigation Light Sets	28

S

Shore Power Cable Holder.....	20
Shore Power Cable Holder Ring.....	20,41
Striker Base Gunnel Mount.....	6
Striker Base Gunnel Mount Replacement Arm.....	6,40
Surface Mount LED Navigation Light Set.....	29
Surface Mount Rod Holders	12

T

Tele-Outrigger Poles	8
Trailer Glyde Slicks.....	25
Transom Mount Rod Rack	17
Trident 3-Rod Cluster	16
Trident Tool Caddy.....	16,41
Tumbler Holders	24



TACO Marine, a division of TACO Metals, Inc.,
is a leading global manufacturer of
Marine and Sport Fishing equipment.
Our product line consists of the following:

Seats & Pedestals

Outrigger Systems

Rod Holders, Racks & Storage Solutions

Canvas & Metal Fabrication

Tube, Pipe & Fittings

Rub Rail, Trim & Marine Extrusions

Hinges & Latches

LED Lighting

Marine Lumber & Poly Accessories

tacomarine.com
info@tacomarine.com
Tech Hotline: 1.800.653.8567

Catalog-TSFmini
6000 6/17

